





1

2

3

4

5

6

REVISION RECORD	
LTR	ECD NO.
	APPROVED:
	DATE:

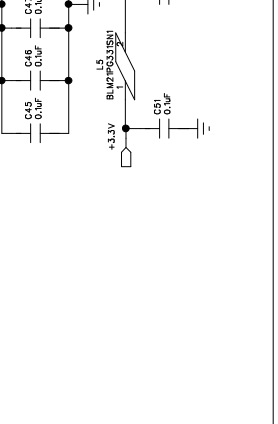
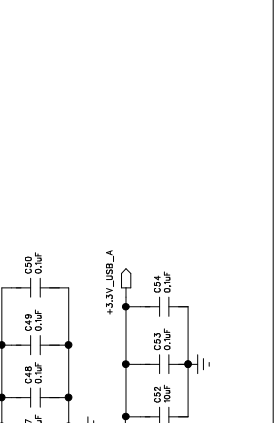
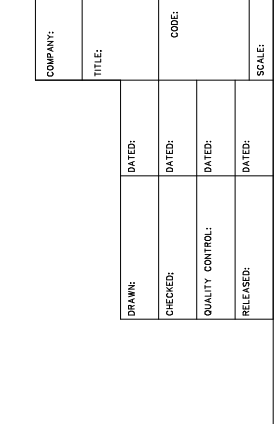
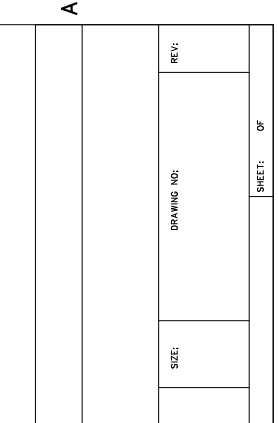
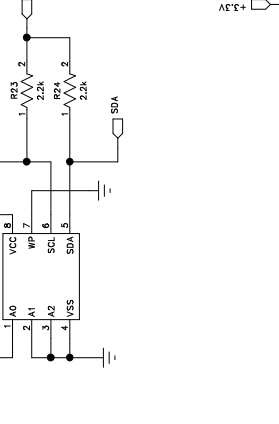
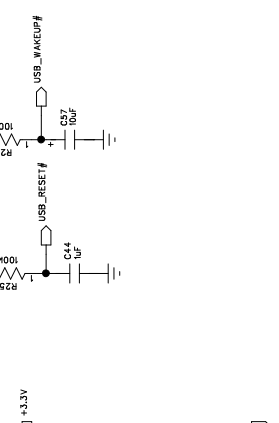
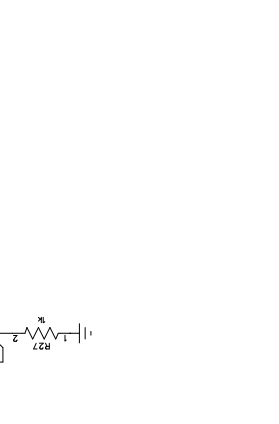
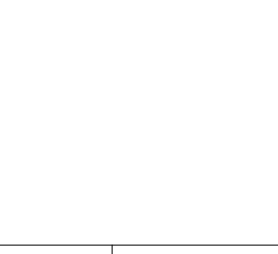
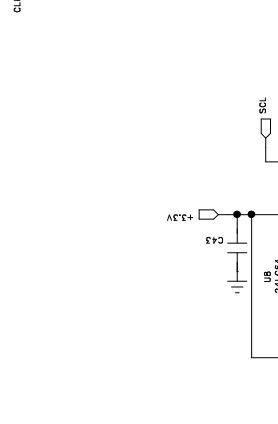
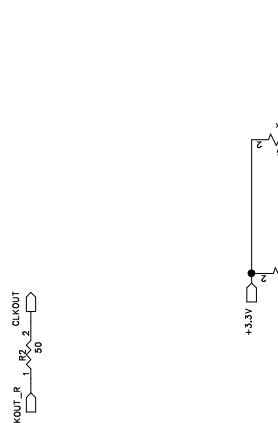
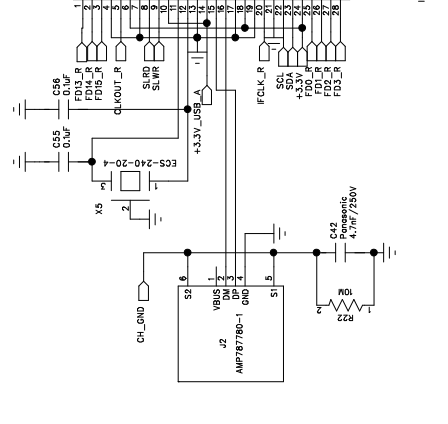
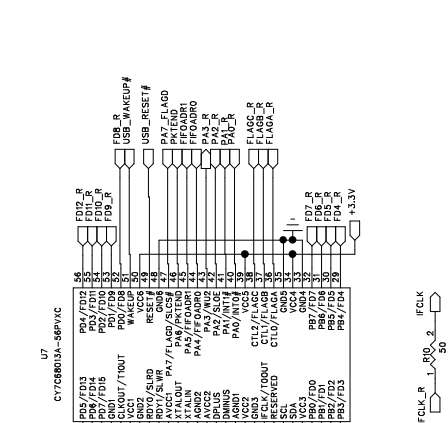
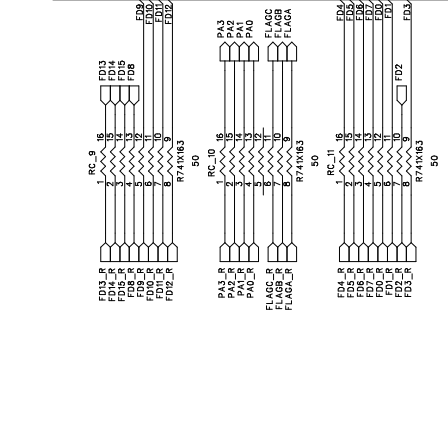
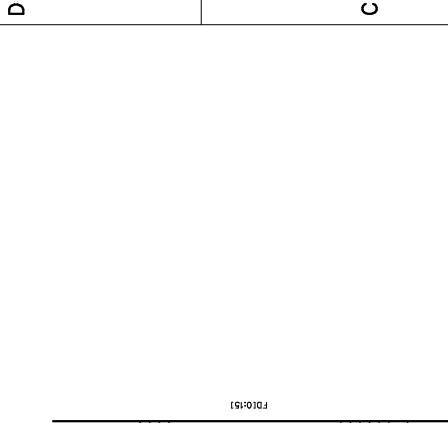

1

2

3

4

5

6

REVISION RECORD	
LTR	APPROVED: DATE:
ECO NO.	

D

C

B

A

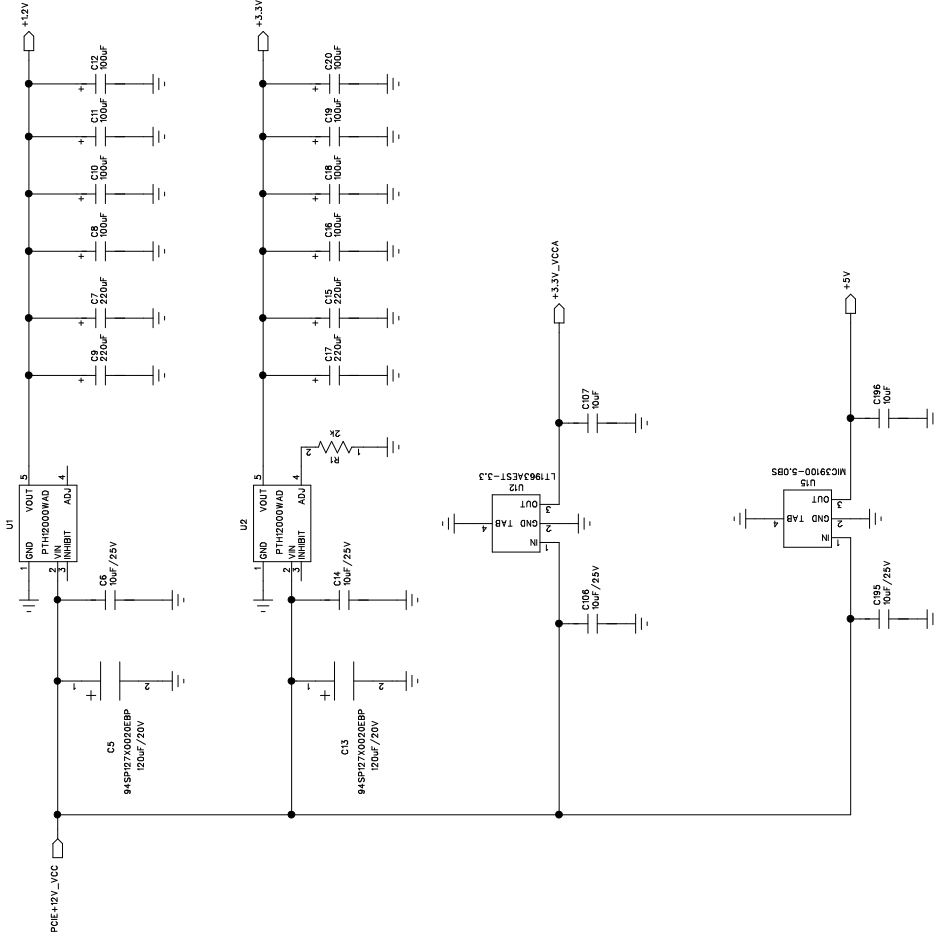

D

C

B

A

COMPANY:		DRAWING NO.:		REV.:	
TITLE:		CODE:		SIZE:	
DRAWN:	DATED:	CHECKED:	DATED:	QUALITY CONTROL:	DATED:
RELEASED:	DATED:				
SCALE:				SHEET: OF	



1

2

3

4

5

6

REVISION RECORD	
LTR	ECD NO.
	APPROVED:
	DATE:

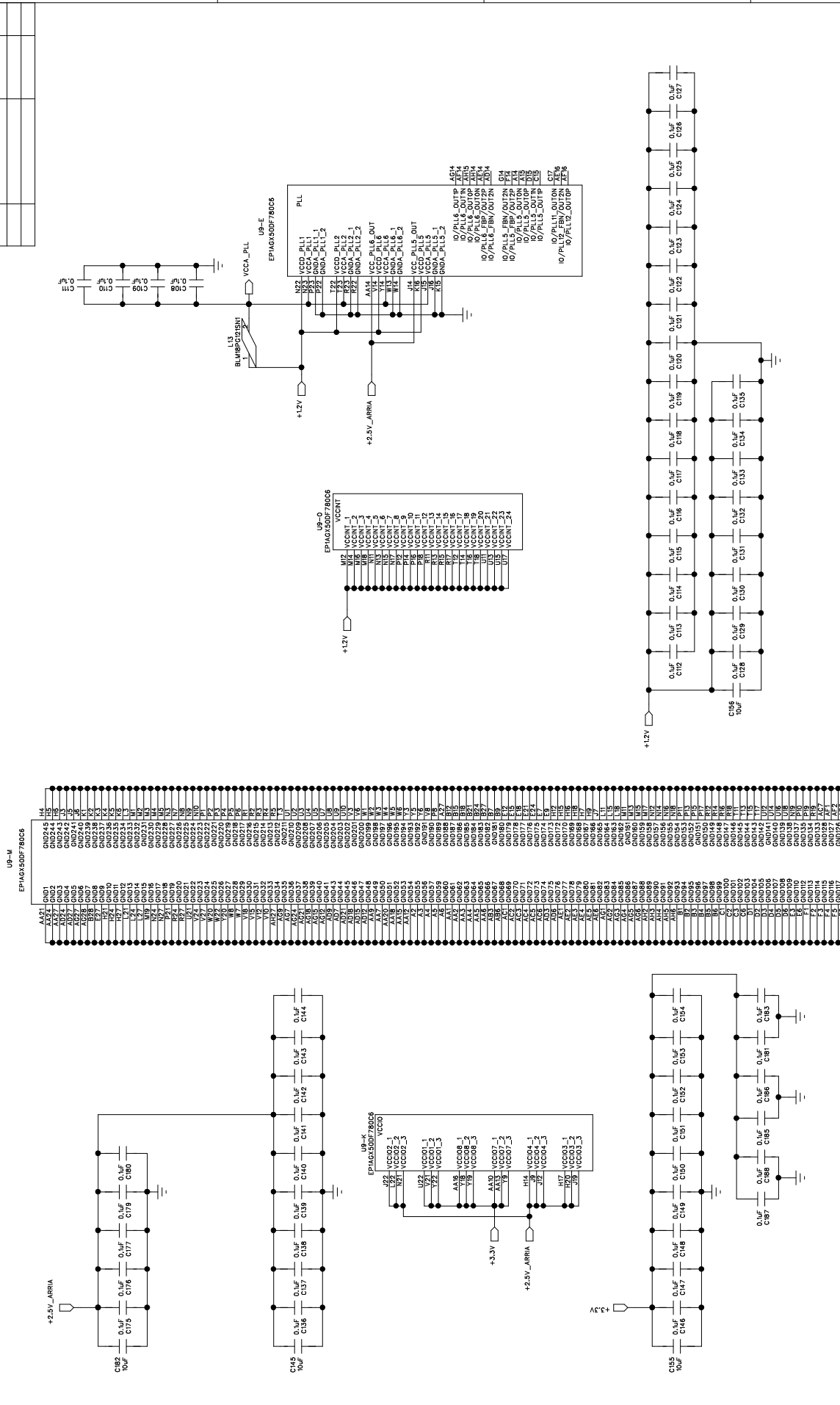

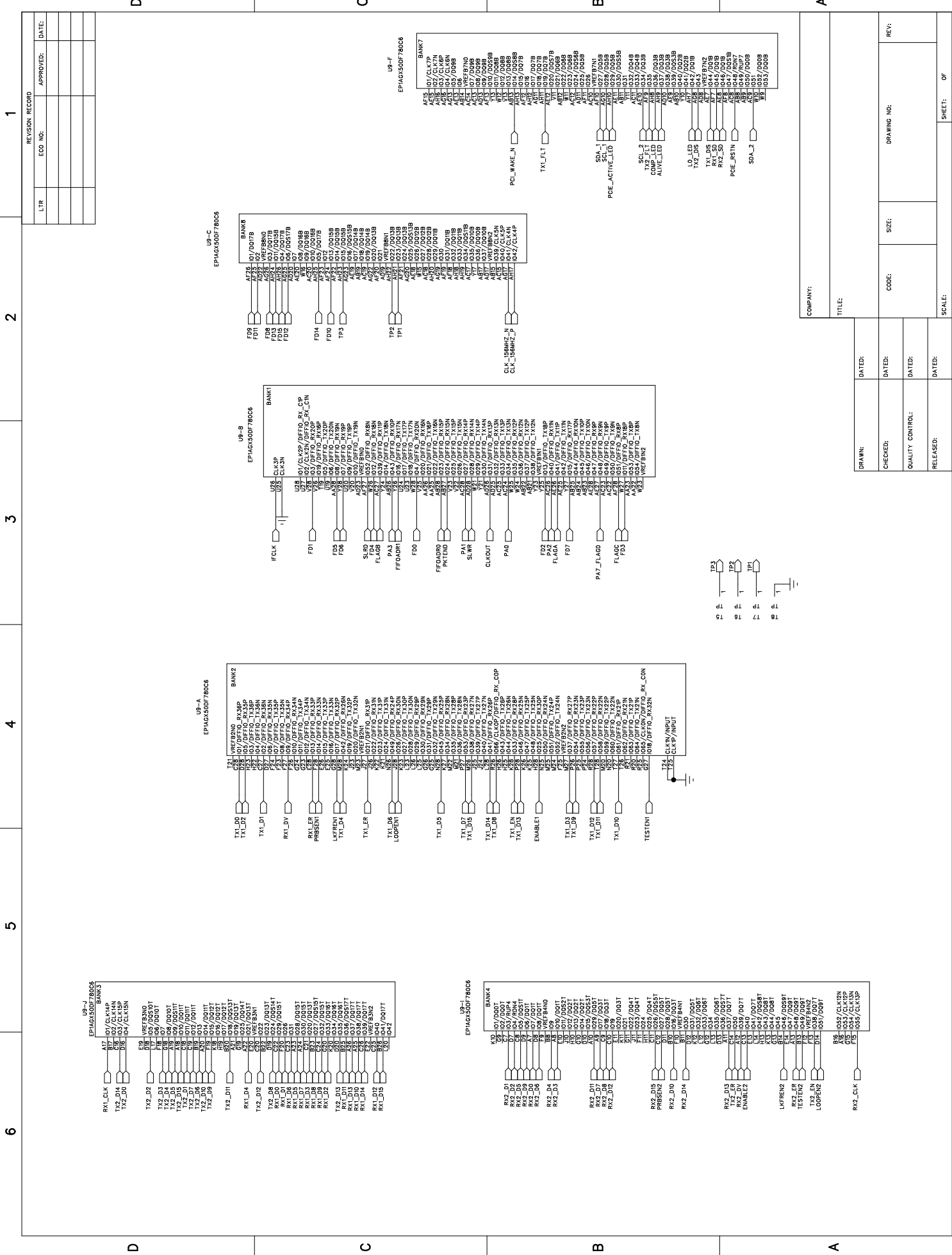

REVISION RECORD	
LTR	APPROVED: DATE:

1	
2	
3	
4	
5	
6	

COMPANY:		DRAWING NO:		REV:	
TITLE:		CODE:		SIZE:	
DRAWN:		CHECKED:		DATED:	
RELEASED:		QUALITY CONTROL:		DATED:	
SCALE:		SHEET:		OF	

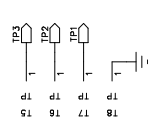

1

2

3

4

5

6

D

C

B

A

REVISION RECORD		
LTR	ECO NO.	APPROVED:

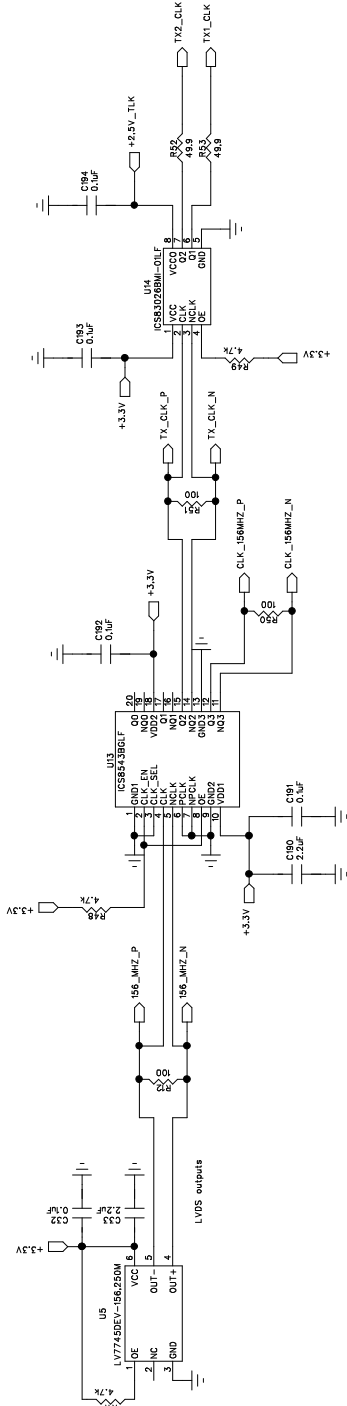
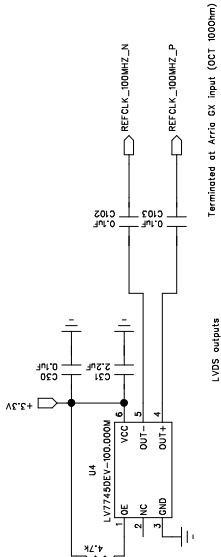

COMPANY:	
TITLE:	
DRAWN:	DATED:
CHECKED:	DATED:
QUALITY CONTROL:	DATED:
RELEASED:	DATED:
CODE:	SIZE:
DRAWING NO.:	
REV.:	
SCALE:	SHEET: OF